

APS 141-166

POMPE A MEMBRANA AD ALTA PRESSIONE
HIGH PRESSURE DIAPHRAGM PUMPS
POMPES A MEMBRANE A HAUTE PRESSION
BOMBAS A MEMBRANA DE ALTA PRESSION
HOCHDRUCK-MEMBRANPUMPEN



Configurazione: 5 membrane in NBR (Desmopan® e Viton a richiesta). Parti a contatto con il liquido: alluminio anodizzato. Di serie: **accumulatore di pressione e valvola di sicurezza**. A richiesta: protezione p.d.f.















Configuration: 5 diaphragms in NBR (Desmopan® and Viton available on request). Parts in contact with spray liquid: anodized aluminium. Standard: **pressure accumulator and safety valve**. On request: PTO protection.

Configuration : 5 membranes en NBR (Desmopan® et Viton à la demande). Parties au contact du liquide : aluminium anodisé. De série : **accumulateur de pression et soupape de sécurité**. À la demande : protection prise de force.















Configuración: 5 membranas en NBR (Desmopan® y Viton bajo pedido). Partes en contacto con el líquido: aluminio anodizado. De serie: **acumulador de presión y válvula de seguridad**. Bajo pedido: protección toma de fuerza (t.d.f.).

Konfigurierung: 5 Membranen aus NBR (Desmopan® und Viton auf Wunsch). Teile im Kontakt mit der Flüssigkeit: eloxiertes Aluminium. Serienmäßig: **Druckspeicher und Sicherheitsventil**. Auf Wunsch: Zapfwellenschutz.

APS 141

	0 bar - 0 p.s.i.				20 bar - 290 p.s.i.				30 bar - 435 p.s.i.				40 bar - 580 p.s.i.				50 bar - 725 p.s.i.									
																										
RPM	l/min	U.S.g.p.m.	HP	kW	l/min	U.S.g.p.m.	HP	kW	l/min	U.S.g.p.m.	HP	kW	l/min	U.S.g.p.m.	HP	kW	l/min	U.S.g.p.m.	HP	kW	l/min	U.S.g.p.m.	HP	kW	kg	lb
400	109	28,8	1,1	0,8	106	28,0	6,0	4,4	104	27,5	8,3	6,1	103	27,2	10,6	7,8	102	26,9	12,9	9,5						
450	122	32,2	1,3	1,1	118	31,2	6,7	4,9	117	30,9	9,4	6,9	116	30,6	12,0	8,8	115	30,4	14,5	10,7						
500	132	34,9	1,4	1,0	129	34,1	7,3	5,4	129	34,1	10,3	7,6	128	33,8	13,2	9,7	128	33,8	16,2	11,9						
550	145	38,3	1,5	1,1	142	37,5	8,1	6,0	142	37,5	11,4	8,4	141	37,2	14,6	10,7	141	37,2	17,8	13,1	56	123,5				

APS 166

	0 bar - 0 p.s.i.				20 bar - 290 p.s.i.				30 bar - 435 p.s.i.				40 bar - 580 p.s.i.				50 bar - 725 p.s.i.									
																										
RPM	l/min	U.S.g.p.m.	HP	kW	l/min	U.S.g.p.m.	HP	kW	l/min	U.S.g.p.m.	HP	kW	l/min	U.S.g.p.m.	HP	kW	l/min	U.S.g.p.m.	HP	kW	l/min	U.S.g.p.m.	HP	kW	kg	lb
400	126	33,3	1,3	1,0	123	32,5	7,0	5,2	121	32,0	9,7	7,1	121	32,0	12,5	9,2	120	31,7	15,1	11,1						
450	142	37,5	1,5	1,1	139	36,7	7,9	5,8	137	36,2	11,0	8,1	136	35,9	14,0	10,3	135	35,7	17,0	12,5						
500	154	40,7	1,6	1,2	151	39,9	8,6	6,3	150	39,6	12,0	8,8	150	39,6	15,5	11,4	148	39,1	18,7	13,8						
550	169	44,6	1,8	1,3	166	43,9	9,4	6,9	164	43,3	13,1	9,6	163	43,1	16,8	12,4	163	43,1	20,5	15,1	56	123,5				

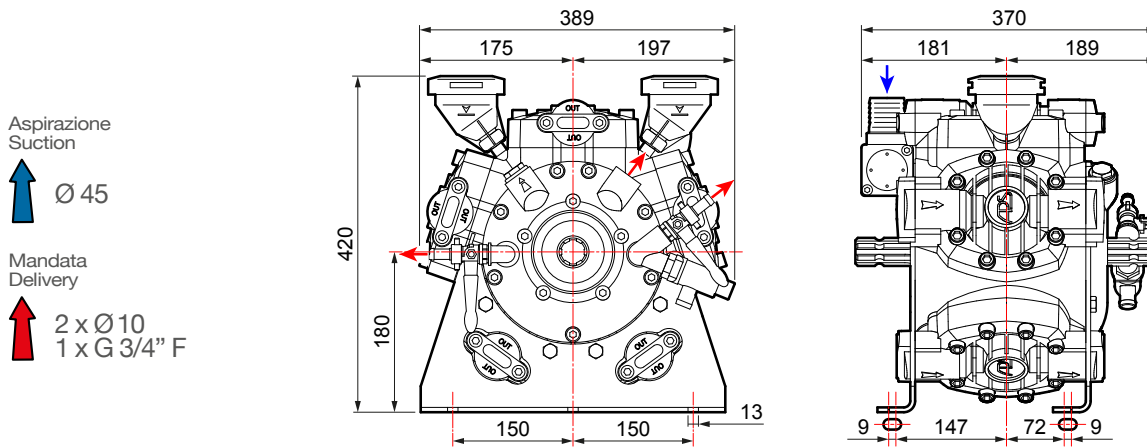

VERSIONI STANDARD · STANDARD VERSIONS · VERSIONS STANDARD · VERSIONES ESTÁNDAR · STANDARDAUSFÜHRUNGEN
Versioni derivate · Versions adapted · Versions dérivées · Versiones derivadas · Von der Standardversion abgeleitete Ausführungen

