

APS 61-71



POMPE A MEMBRANA AD ALTA PRESSIONE
HIGH PRESSURE DIAPHRAGM PUMPS
POMPES A MEMBRANE A HAUTE PRESSION
BOMBAS A MEMBRANA DE ALTA PRESSION
HOCHDRUCK-MEMBRANPUMPEN



Configurazione: 3 membrane in NBR (Desmopan® e Viton a richiesta). Parti a contatto con il liquido: alluminio anodizzato. Di serie: **accumulatore di pressione e valvola di sicurezza**. A richiesta: protezione p.d.f..

Configuration: 3 diaphragms in NBR (Desmopan® and Viton available on request). Parts in contact with spray liquid: anodized aluminium. Standard: **pressure accumulator and safety valve**. On request: PTO protection.

Configuration : 3 membranes en NBR (Desmopan® et Viton à la demande). Parties au contact du liquide : aluminium anodisé .De série : **accumulateur de pression et soupape de sécurité**. À la demande : protection prise de force.

Configuración: 3 membranas en NBR (Desmopan® y Viton bajo pedido). Partes en contacto con el líquido: aluminio anodizado. De serie: **acumulador de presión y válvula de seguridad**. Bajo pedido: protección toma de fuerza (t.d.f.).

Konfigurierung: 3 Membranen aus NBR (Desmopan® und Viton auf Wunsch). Teile im Kontakt mit der Flüssigkeit: eloxiertes Aluminium. Serienmäßig: **Druckspeicher und Sicherheitsventil**. Auf Wunsch: Zapfwellenschutz.

APS 61

	0 bar - 0 p.s.i				20 bar - 290 p.s.i				30 bar - 435 p.s.i				40 bar - 580 p.s.i				50 bar - 725 p.s.i					
	Pressure		Power		Pressure		Power		Pressure		Power		Pressure		Power		Pressure		Power		Weight	
RPM	l/min	U.S.g.p.m.	HP	kW	l/min	U.S.g.p.m.	HP	kW	l/min	U.S.g.p.m.	HP	kW	l/min	U.S.g.p.m.	HP	kW	l/min	U.S.g.p.m.	HP	kW	kg	lb
400	49,4	13,1	0,5	0,4	47,7	12,6	2,7	2,0	47,4	12,5	3,8	2,8	44,6	11,8	4,6	3,4	44,2	11,7	5,8	4,2	18,4	40,6
450	55,6	14,7	0,6	0,4	53,0	14,0	3,0	2,2	52,8	13,9	4,2	3,1	50,2	13,3	5,2	3,8	49,7	13,1	6,5	4,8		
500	59,9	15,8	0,6	0,4	58,3	15,4	3,3	2,4	58,0	15,3	4,6	3,4	56,6	15,0	5,8	4,3	56,1	14,8	7,3	5,3		
550	65,9	17,4	0,7	0,5	64,2	17,0	3,6	2,6	63,8	16,9	5,1	3,8	62,3	16,5	6,4	4,7	61,7	16,3	8,0	5,9		

APS 71

	0 bar - 0 p.s.i				20 bar - 290 p.s.i				30 bar - 435 p.s.i				40 bar - 580 p.s.i				50 bar - 725 p.s.i					
	Pressure		Power		Pressure		Power		Pressure		Power		Pressure		Power		Pressure		Power		Weight	
RPM	l/min	U.S.g.p.m.	HP	kW	l/min	U.S.g.p.m.	HP	kW	l/min	U.S.g.p.m.	HP	kW	l/min	U.S.g.p.m.	HP	kW	l/min	U.S.g.p.m.	HP	kW	kg	lb
400	53,0	14,0	0,5	0,4	51,7	13,7	2,9	2,1	50,8	13,4	4,0	2,9	50,4	13,3	5,2	3,8	50,0	13,2	6,5	4,8	18,4	40,6
450	59,2	15,6	0,6	0,5	57,8	15,3	3,3	2,4	56,8	15,0	4,6	3,4	56,3	14,9	5,9	4,4	55,8	14,7	7,3	5,4		
500	65,0	17,2	0,8	0,6	63,5	16,8	3,7	2,7	62,4	16,5	5,2	3,8	61,8	16,3	6,7	4,9	61,3	16,2	8,3	6,1		
550	71,3	18,8	0,9	0,7	69,6	18,4	4,1	3,0	68,4	18,1	5,7	4,2	67,8	17,9	7,3	5,4	67,2	17,8	9,1	6,7		

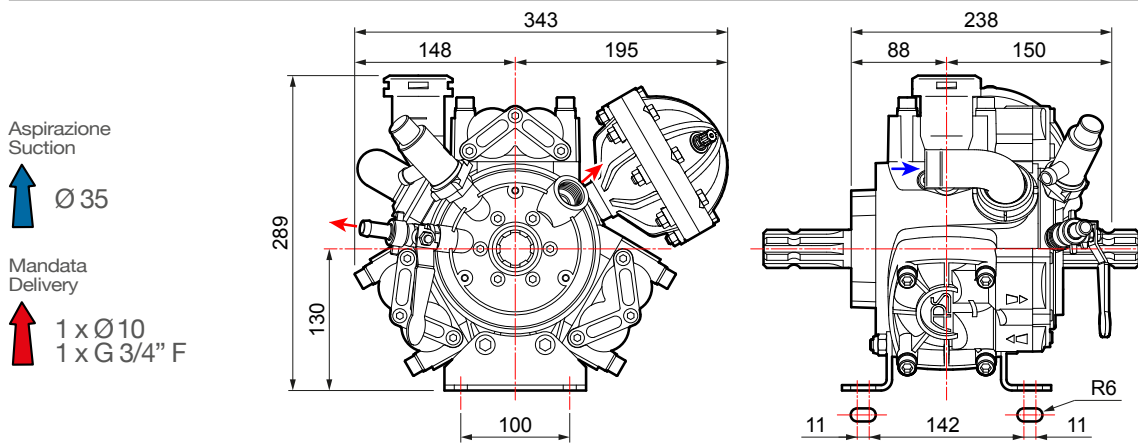

Aspirazione
Suction



Mandata
Delivery

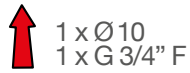

VERSIONI STANDARD · STANDARD VERSIONS · VERSIONS STANDARD · VERSIONES ESTÁNDAR · STANDARD AUSFÜHRUNGEN

Versioni derivate · Versions adapted · Versions dérivées · Versiones derivadas · Von der Standardversion abgeleitete Ausführungen

A



Albero non passante
Single shaft
Arbre non traversant
Cigüeñal no pasante
Welle

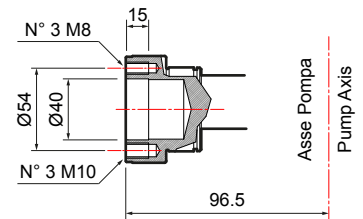
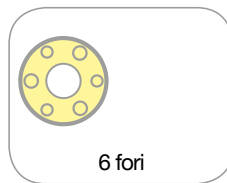

Flangiata a motore idraulico
Flanged to hydraulic motor
Bridée à un moteur hydraulique
Conexión con brida a motor hidráulico
An Hydraulikmotor geflanscht



Kit Cardano
Male PTO kit
Kit Cardan
Kit Cardán
Kardankit



Kit Cilindrico
Cylindrical kit
Kit cylindrique
Kit cilindrico
Zylinderkit



Riduttore di giri
Reduction gearbox
Réducteur de tours
Reductor de revoluciones
Untersetzungsgetriebe



Kit attacco rapido
Quick coupling kit
Kit accouplement rapide
Kit conexión rápida
Schnellkupplungsset



Kit Puleggia
Pulley kit
Kit Poulie
Kit Polea
Riemenscheibenkit

B



Albero passante
Through shaft
Arbre traversant
Cigüeñal pasante
Durchgangswelle

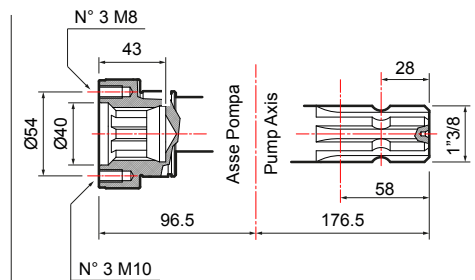
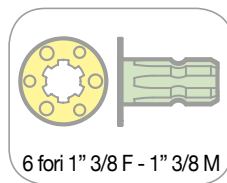

Flangiata a motore idraulico
Flanged to hydraulic motor
Bridée à un moteur hydraulique
Conexión con brida a motor hidráulico
An Hydraulikmotor geflanscht

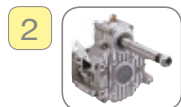

Flangiata a moltiplicatore
Coupled to overgearbox
Bridée à un multiplicateur
Conexión con brida a multiplicador
An Übersetzungsgetriebe geflanscht



Kit Cardano
Male PTO kit
Kit Cardan
Kit Cardán
Kardankit



Kit Cilindrico
Cylindrical kit
Kit cylindrique
Kit cilindrico
Zylinderkit



Riduttore di giri
Reduction gearbox
Réducteur de tours
Reductor de revoluciones
Untersetzungsgetriebe



Kit attacco rapido
Quick coupling kit
Kit accouplement rapide
Kit conexión rápida
Schnellkupplungsset



Kit Puleggia
Pulley kit
Kit Poulie
Kit Polea
Riemenscheibenkit

C



Albero passante
Through shaft
Arbre traversant
Cigüeñal pasante
Durchgangswelle

